

ALLEGATO N. 4 - ELABORATO PLANIMETRICO E SCHEDE CATASTALI

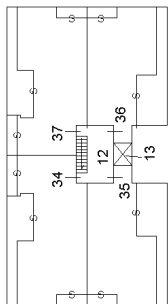

PIANO SECONDO

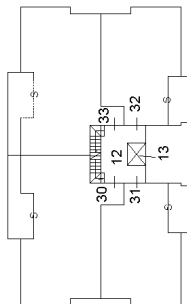

PIANO PRIMO

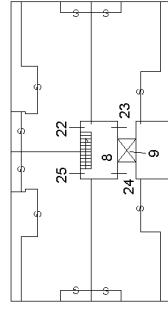

PIANO SECONDO

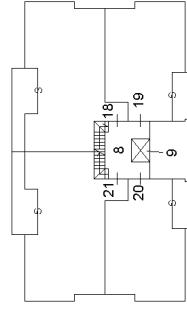

PIANO PRIMO

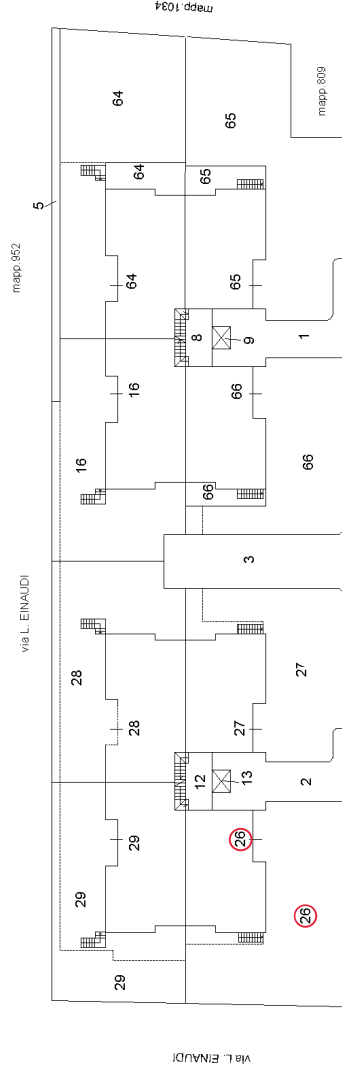

Via DEL DONATORE

PIANO TERRA

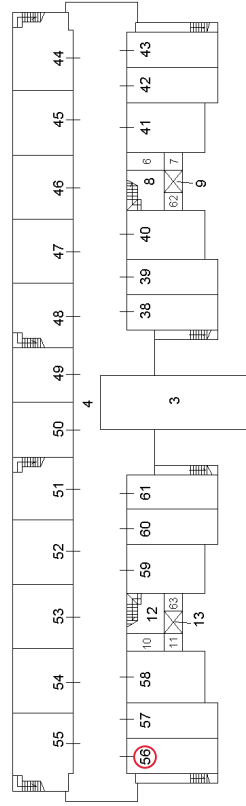

PIANO PRIMO SOTTOSTRADA

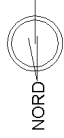

**Agenzia del Territorio
CATASTO FABBRICATI
Ufficio Provinciale di
Treviso**

Dichiarazione protocollo n. TV0244885 del 14/07/2009

Planimetria di u.i.u. in Comune di Monastier Di Treviso

Via Del Donatore

civ.

Identificativi Catastali:

Sezione: A

Foglio: 8

Particella: 1080

Subalterno: 26

Compilata da:

Zago Fabrizio

Iscritto all'albo:
Geometri

Prov. Treviso

N. 3071

Scheda n. 1

Scala 1:200

via Einaudi

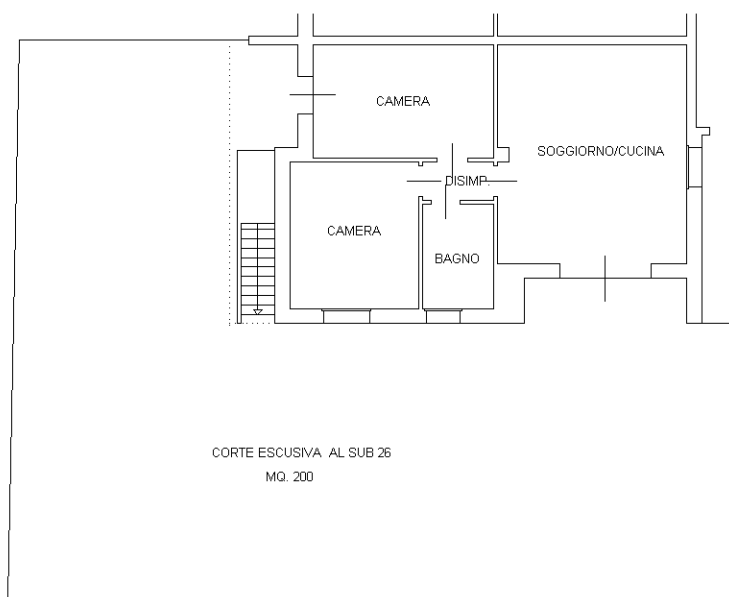

CORTE ESCUSIVA AL SUB 26
MQ. 200

via del Donatore

piano terra H=2.70

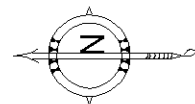

Ultima planimetria in atti



**Agenzia del Territorio
CATASTO FABBRICATI
Ufficio Provinciale di
Treviso**

Dichiarazione protocollo n. TV0244885 del 14/07/2009

Planimetria di u.i.u. in Comune di Monastier Di Treviso

Via Del Donatore

civ.

Identificativi Catastali:

Sezione: A

Foglio: 8

Particella: 1080

Subalterno: 56

Compilata da:
Zago Fabrizio

Iscritto all'albo:
Geometri

Prov. Treviso

N. 3071

Scheda n. 1

Scala 1:200

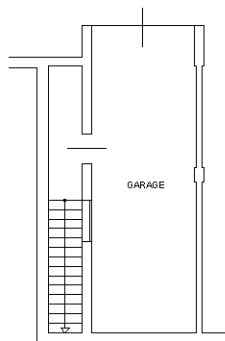

piano interrato H=2.40

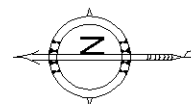

Ultima planimetria in atti

